

Gdudhi[®]
a trusted name

MADE STRONG MADE TO LEAD

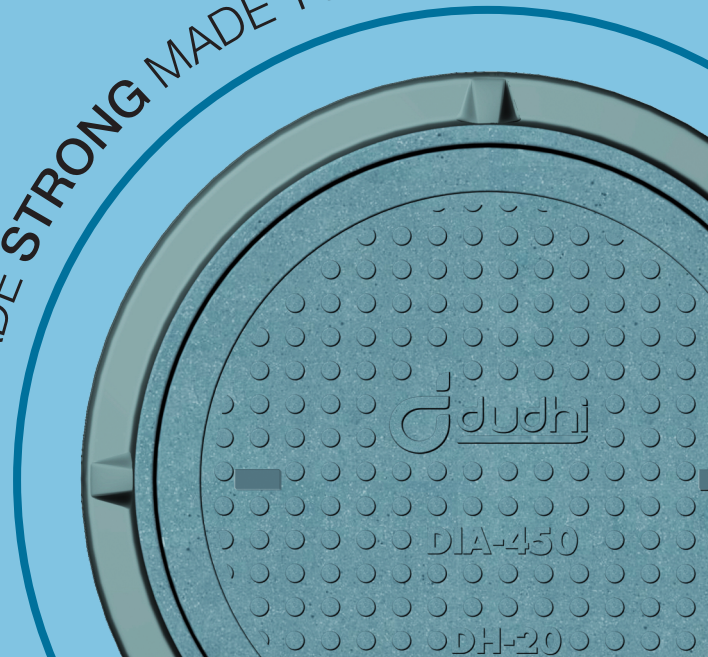



The Company

Dudhi Industries offer an elegant range of quality products related to Indian construction industries since many years and with complete success in serving Gypsum base products in the market, now launching an innovative product i.e. Fiber Reinforced Polymer – FRP which is a composite material made of a polymer matrix, reinforced with Glass Fiber.

With strong technical team and In-house testing facility, we have passion for developing new products at regular intervals. Our R&D department has enabled us to develop technically superior and quality efficient products.

Being an ISO 9001-2015 & 14001-2015 certified company, we have complete manufacturing facilities with advance technology at our factories equipped with advanced automatic machines so that we are able to deliver quality product as well as customized solution to the customer as required.

Dudhi Fiber Reinforced polymer - FRP products are basically manufactured with world class Multilayer Composite Unifier (MCU) Polymer technology by compressed molding system and the woven fiber fabrics are randomly arranged in it which provide more strength and flexibility to the product with complex shapes. With the use of special quality raw materials, the products are having ability to sustain heavy load vehicular traffic movement on it apart from its aesthetic value.

► Product range

The range of products offered by us, are as per the requirements of building segments as under:



Gypsum Based Products	Cement Based Products	FRP Products
Gypsum Plaster (Brick Solution)	Tile Adhesive	Manhole Cover
Gypsum Plaster (Brick Solution-95)	Marble Adhesive	Grating
Gypsum Spray Solution	Block Mortar	Recessed Cover
Gypsum Acoustic Plaster	Skim Coat Plaster	Dustbin
Plaster of Paris	Wall Plast	Innovative Planter
Gypsum Plaster Bond	Premix Plaster	Customized FRP Product
Crack Filler		



कीमत नहीं, गुणवत्ता देखें।

- Dudhi FRP products categories of 2.5T to 5.0T are of very good quality. These products are for indoor use only.
- The cover is fitted smoothly with frame & is quite safe, in use.
- It provides smooth leveled surface which protects from accidental occurrences.

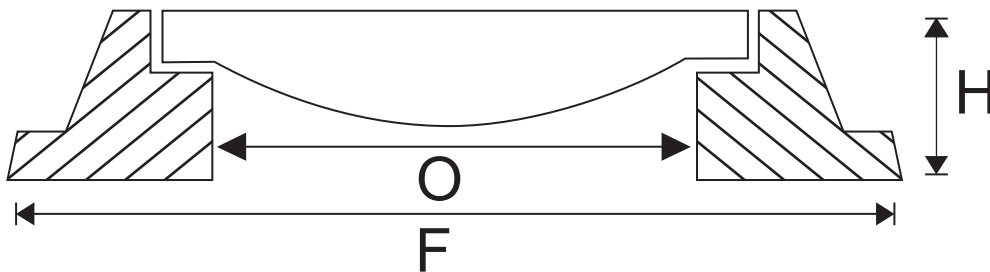
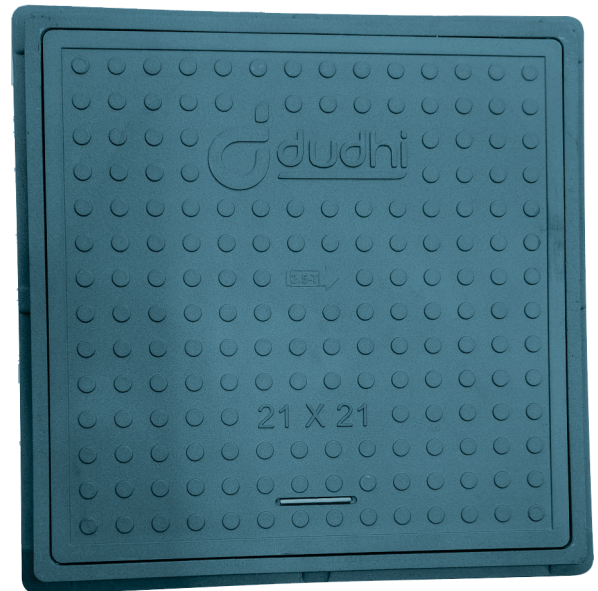

Item	Loading Capacity	Clear Opening (mm) O)	Frame Size(mm) (F)	Frame Height (H)	Net Weight (KG)
LMHS-10	2.5/5 mt	180	250	25	2.5
LMHS-12	2.5/5 mt	220	300	25	3.0
LMHS-15	2.5/5 mt	300	380	25	4.5
LMHS-18	2.5/5 mt	350	450	28	8.0
LMHS-21	2.5/5 mt	425	535	28	11.0
LMHS-24	2.5/5 mt	490	600	28	14.0
LMHS-28	2.5/5 mt	600	710	30	19.0



Anti-Theft



Long Life



Aesthetics



Lightweight



Weather Proof

FRP Manhole Cover - Circular

- **Dudhi FRP** circular design manhole cover is aesthetically very impressive.
- The cover is fitted smoothly with frame & is quite safe, in use.
- It provides smooth leveled surface which protects from accidental occurrences.

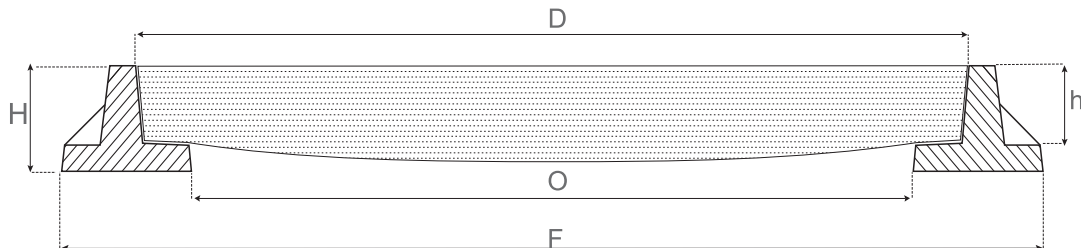
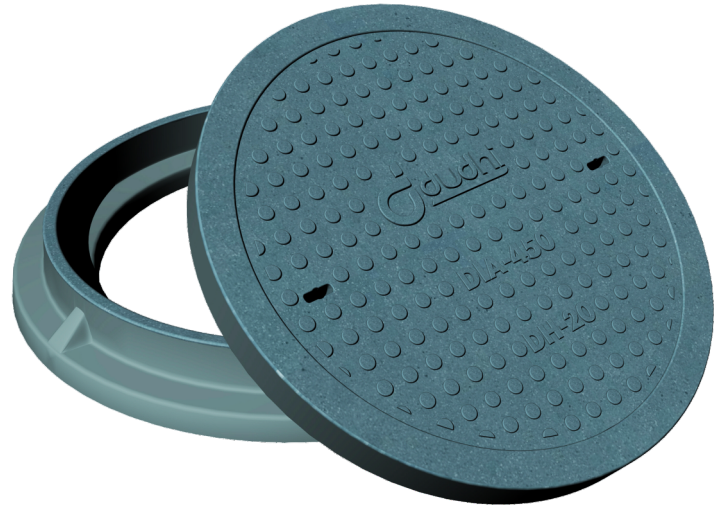
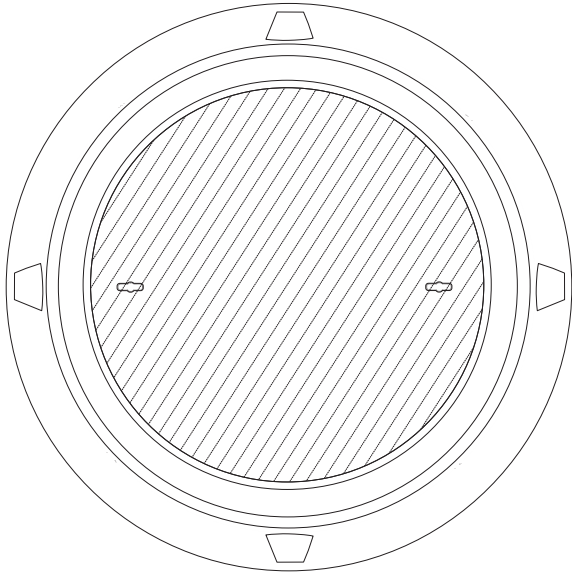

Item	Loading Capacity	Clear Opening (O)	Cover Size (D)	Frame Size (F)	Frame Height (H)	Cover Thickness (h)	Net Weight (Kg.)
MHC-300	2.5/5/10 mt	300	360	460	50	25	13
MHC-300	20/40 mt	300	360	460	75	40	16
MHC-450	2.5/5 mt	450	510	610	50	20	18
MHC-450	10/20/40 mt	450	520	615	75	45	29
MHC-500	2.5/5/10 mt	500	555	640	60	30	22
MHC-530	2.5/5 mt	530	585	690	50	20	26
MHC-530	10/20/40 mt	530	625	730	75	40	47
MHC-600	2.5/5/10 mt	600	665	750	50	25	30
MHC-600	20/40 mt	600	670	770	80	45	53



Shock Proof



Zero Maintenance



High-Load Capacity



No-Colour Fading



Leak Proof

FRP Manhole Cover - Square

- FRP manhole cover, in square pattern is accepted globally due to its impressive design.
- On top side of the cover, the lifting key holes provide easy handling at the time of service, not to allow foul smell to emanate from the chamber and does not allow foreign particles to enter the chamber too.
- Mostly the square manhole cover is used in various sizes as comfort to customer as per their choice.

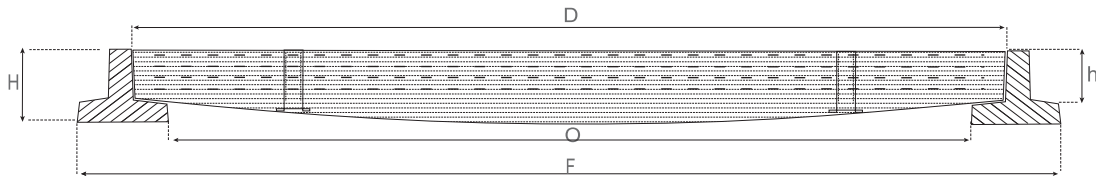
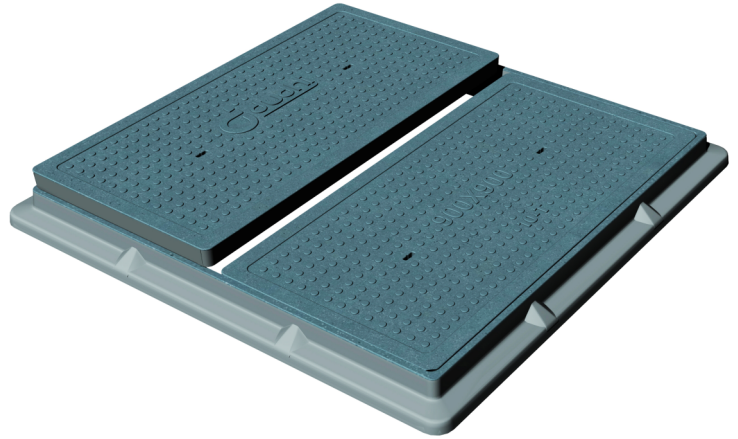
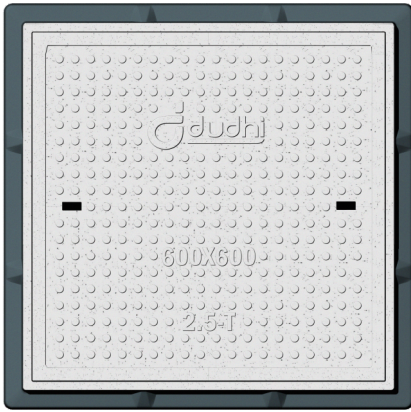

Item	Loading Capacity	Clear Opening (O)	Cover Size (D)	Frame Size (F)	Frame Height (H)	Cover Thickness (h)	Net Weight (Kg.)
MHS-225	2.5/5 mt	225 x 225	250	310	45	15	6
MHS-225	10/20/40 mt	225 x 225	290	375	55	25	11
MHS-300	2.5/5 mt	300 x 300	320	380	45	17	7
MHS-300	10 mt	300 x 300	342	420	45	20	11
MHS-300	20/40 mt	300 x 300	375	475	70	40	24
MHS-450	2.5/5 mt	450 x 450	475	540	45	17	14
MHS-450	10 mt	450 x 450	490	570	40	20	19
MHS-450	20/40 mt	450 x 450	520	620	65	40	41
MHS-600	2.5/5 mt	600 x 600	640	710	55	25	28
MHS-600	10 mt	600 x 600	660	755	50	25	43
MHS-600	20 mt	600 x 600	665	765	65	40	59
MHS-600	40 mt	600 x 600	670	780	80	45	72
MHS-750	10/20/40 mt	750 x 750	835	950	85	40	94
MHS-900	10/20/40 mt	900 x 900	990 x 495	1115 x 1115	90	35	140
MHDS-1200	40 mt	1200 x 1200	1270 x 635	1400 x 1400	80	40	210

- Dudhi FRP manhole cover double door pattern is a handy system.
- It is easy to carry and easy to maintain in service.
- Asthetically it is meant for bigger size manhole cover.



FRP Manhole Cover - Rectangular

- Rectangular manhole cover is basically required in areas in specific use where adjustment of space or width-reduction is required.
- Generally, bigger size of manhole cover is chosen for the rectangular pattern.

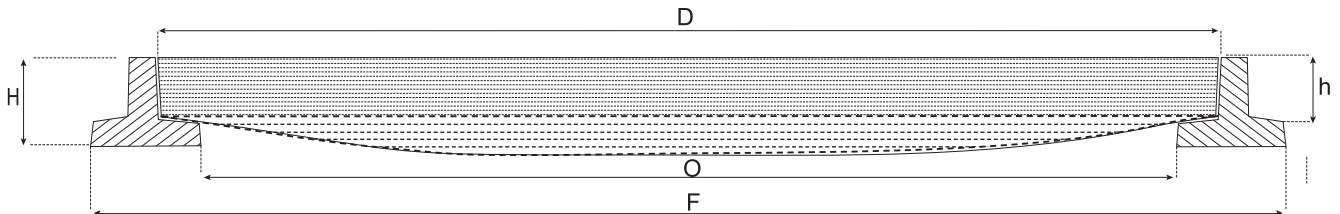
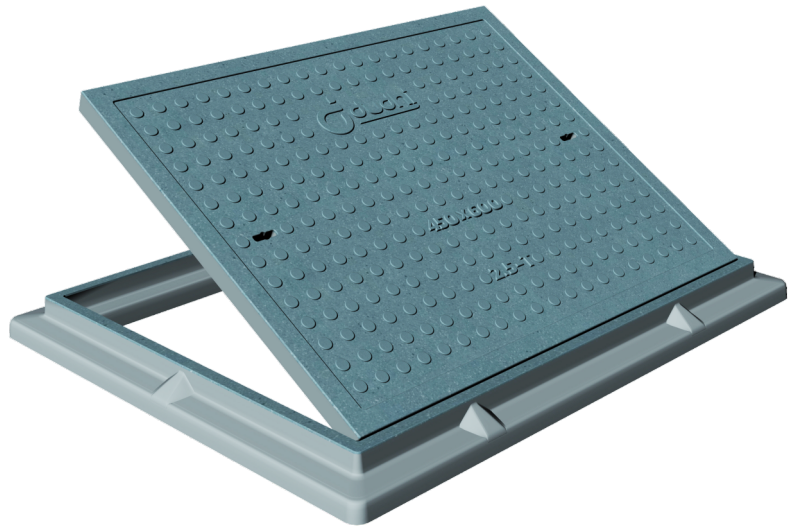
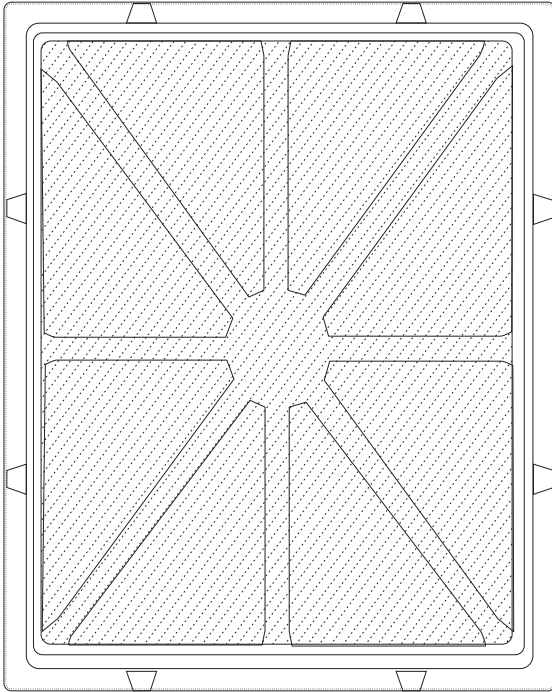

Item	Loading Capacity	Clear Opening (O)	Cover Size (D)	Frame Size (F)	Frame Height (H)	Cover Thickness (h)	Net Weight (Kg.)
MHR-3045	2.5/5 mt	300 x 450	330 x 480	390 x 540	35	17	8
MHR-4560	2.5/5 mt	450 x 600	510 x 660	610 x 760	50	20	34
MHR-4560	10/20/40 mt	450 x 600	520 x 670	620 x 770	70	40	49
MHR-4590	2.5/5 mt	450 x 900	510 x 955	580 x 1025	50	25	47
MHR-4590	10/20/40 mt	450 x 900	520 x 970	615 x 1065	85	60	65
MHR-4590	20 mt	480 x 900	445 x 960	615 x 1000	45	35	48
MHR-6075	10/20/40 mt	600 x 750	685 x 830	800 x 945	85	40	80
MHR-6090	10/20/40 mt	600 x 900	670 x 970	770 x 1070	90	57	88
MHR-7590	10/20/40 mt	750 x 900	840 x 990	965 x 1120	85	30	118



- Water tank cover made of **Dudhi FRP** product, represents a hygiene article.
- Functionally, it has to keep the water clean inside the tank.
- A special type of seal is used in between frames and top cover to make the cover air proof though outside water is not allowed inside the tank.

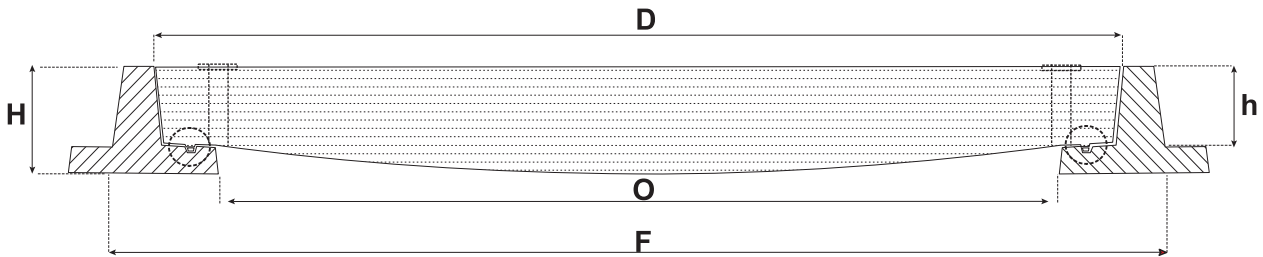
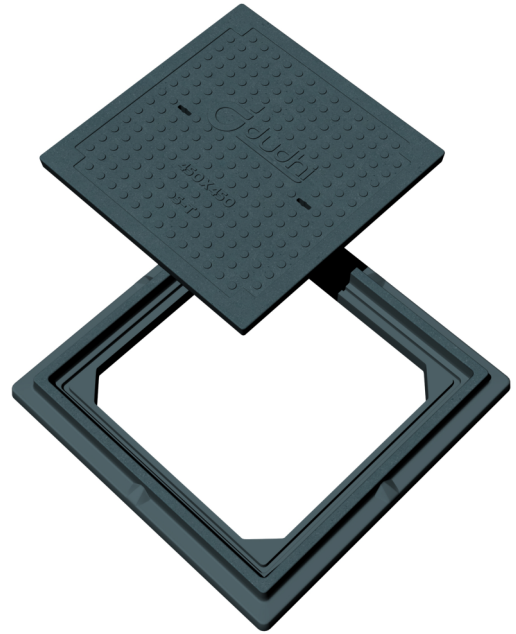
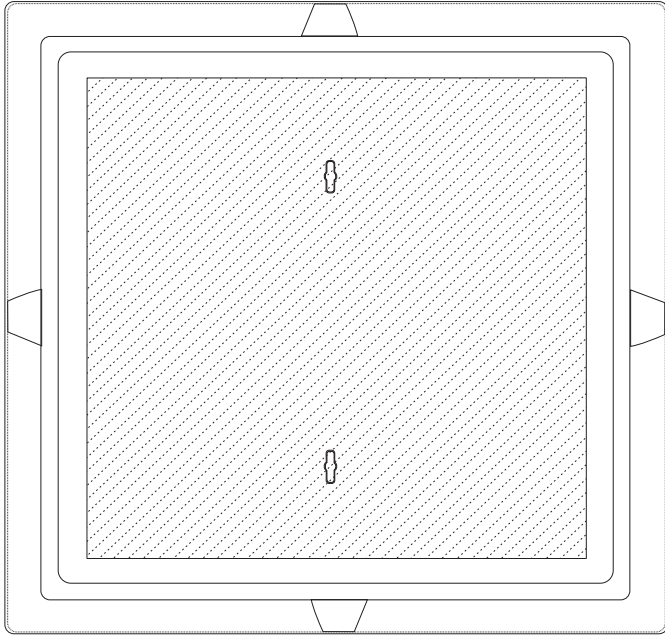

Item	Loading Capacity	Clear Opening (O)	Cover Size (D)	Frame Size (F)	Frame Height (H)	Cover Thickness (h)	Net Weight (Kg.)
WTS-450	2.5/5 mt	450 x 450	515	570	50	20	24
WTS-450	10 mt	450 x 450	490	615	55	25	30
WTS-450	20 / 40 mt	450 x 450	545	650	80	40	53
WTS-600	2.5/5 mt	600 x 600	660	720	55	22	34
WTS-600	10 mt	600 x 600	660	765	55	25	44
WTS-600	20 / 40 mt	600 x 600	710	820	85	50	86
WTS-750	10/20/40 mt	750 x 750	835	950	80	40	103
WTS-900	40 mt	900 x 900	995	1095	80	40	115



Anti-Theft



Long Life



Aesthetics



Lightweight



Weather Proof

- Dudhi FRP gully grating in square/circular shapes are very attractive with its double slitting rows which provides an aesthetic view when it is fixed on chamber.
- Basically, single chamber in square size fulfill the requirement of draining out the waste/rain water.

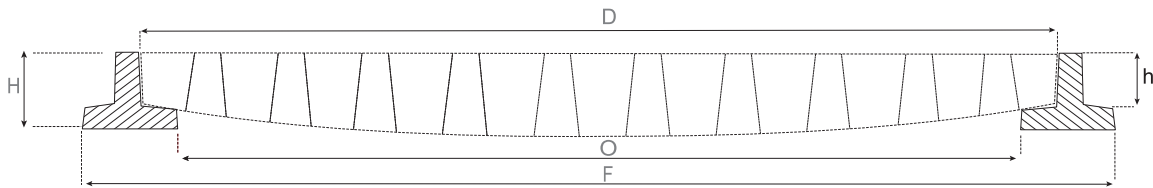
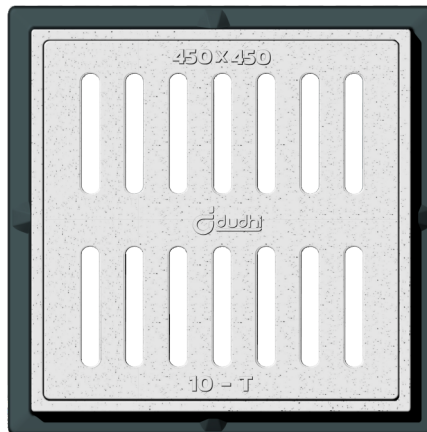
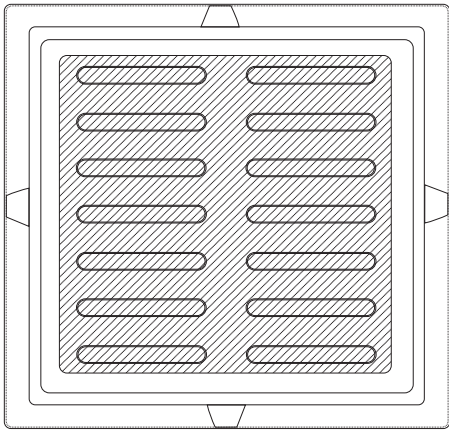

Item	Loading Capacity	Clear Opening (O)	Cover Size (D)	Frame Size (F)	Frame Height (H)	Cover Thickness (h)	Net Weight (Kg.)
SGS-300	2.5/5/10 mt	300 x 300	365	450	50	25	13
SGS-300	20/40 mt	300 x 300	395	500	70	40	24
SGS-450	2.5/5/10 mt	450 x 450	495	555	45	30	18
SGS-450	20/40 mt	450 x 450	520	620	70	45	35
SGS-595	2.5/5 mt **		595			30	16
SGS-600	2.5/5 mt	600 x 600	645	710	50	30	27
SGS-600	10/20/40 mt	600 x 600	665	770	65	40	50
SGS-600*	10/20/40 mt	600 x 600	665	770	65	40	50
SGS-750	10/20/40 mt	750 x 750	835	950	80	40	89
SGS-900	10 mt	900 x 900	950	1050	60	30	112
SGS-900	20/40 mt	900 x 900	970	1070	100	50	160
SGC-560	5/10 mt	560	610	705	55	30	22
SGC-600	5/10 mt	600	680	775	70	35	44
SGC-600	20/40 mt	600	695	815	80	50	53

*Round Hole

**Cover Only



Shock Proof



Zero Maintenance



High-Load Capacity



No-Colour Fading



Leak Proof

- Rectangular grating have its own space with special feature maintaining continuity of water drainage with an attractive view.
- The place like basement, Ramps as well around the green lawn basically need this grating.

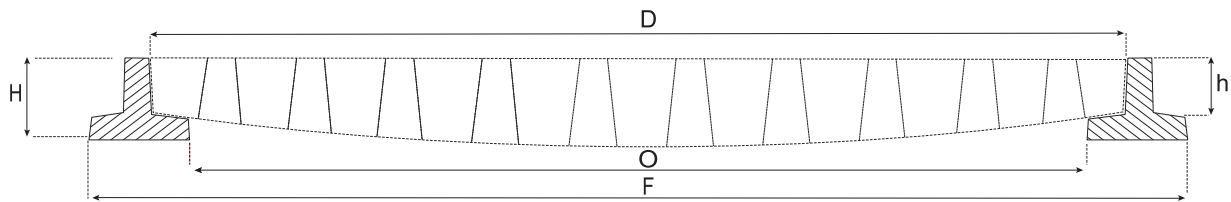
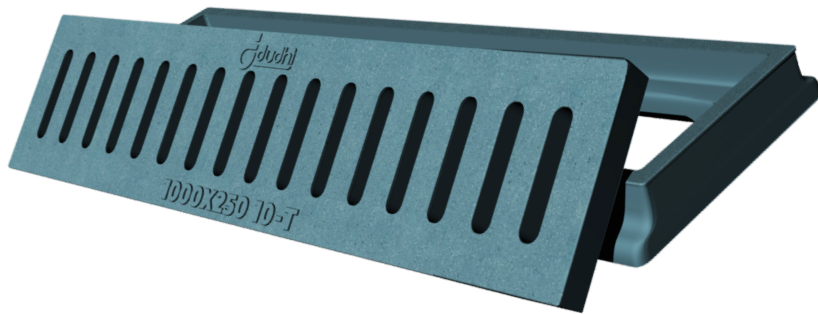

Item	Loading Capacity	Clear Opening (O)	Cover Size (D)	Frame Size (F)	Frame Height (H)	Cover Thickness (h)	Net Weight (Kg.)
SGR-15100	2.5/5 mt	150 x 1000	210 x 1050	280 x 1090	55	30	20
SGR-15100	10/20/40 mt	150 x 1000	230 x 1080	340 x 1125	70	35	35
SGR-20100	2.5/5 mt	200 x 1000	275 x 1065	335 x 1100	55	30	22
SGR-20100	10/20 mt	200 x 1000	275 x 1070	390 x 1125	70	40	39
SGR-20100	40 mt	200 x 1000	350 x 1100	420 x 1155	85	50	55
SGR-25100	2.5/5/10 mt	250 x 1000	300 x 1045	360 x 1080	45	30	23
SGR-25100	20/40 mt	250 x 1000	340 x 1095	450 x 1140	70	40	49
SGR-30100	2.5/5/10 mt	300 x 1000	365 x 1060	425 x 1090	50	30	28
SGR-30100	20/40 mt	300 x 1000	390 x 1090	500 x 1135	70	40	55
SGR-28107	10 mt **		280 x 1070			45	19
SGR-38990	20 mt		380 x 990			40	26
SGR-43105	2.5/5 mt **		430 x 1055			30	28
SGR-47100	40 mt **		470 x 1000			40	52
SGR-51100	2.5/5 mt **		510 x 1000			45	52
SGR-1520	40 mt	150 x 200	215 x 265	290 x 340	65	40	7
SGR-3045	2.5/5 mt	300 x 450	330 x 480	390 x 540	35	17	8
SGR-3045	10/20/40 mt	300 x 450	380 x 525	450 x 605	70	40	21
SGR-4550	5 mt	450 x 500	505 x 555	590 x 635	55	30	23
SGR-4560	2.5/5 mt	450 x 600	505 x 655	570 x 720	55	35	25
SGR-4560	10/20/40 mt	450 x 600	515 x 665	620 x 765	70	45	40
SGR-4590	10/20/40 mt	450 x 900	520 x 970	605 x 1010	65	45	52
SGR-6090	10/20/40 mt	600 x 900	675 x 975	780 x 1080	70	40	74
SGR-6869	20 mt **		680 x 690			40	38

**Cover Only



Shock
Proof



Zero
Maintenance



High-Load
Capacity



No-Colour
Fading



Leak
Proof

- Dudhi FRP Tree Grating is recommended to save trees from RCC structure.
- Dudhi FRP lawn cover is recommended for green area.
- Conceptually this system does not disturb the continuity of greenery as required.
- It is basically a ready pit which carries the grass on top and having ability to drain out the excess water from the lawn.

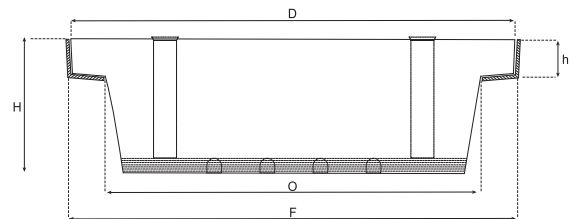
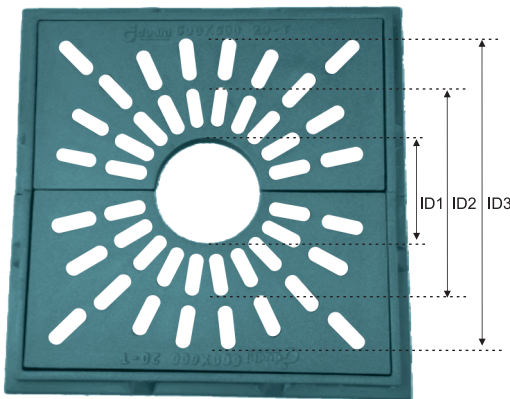
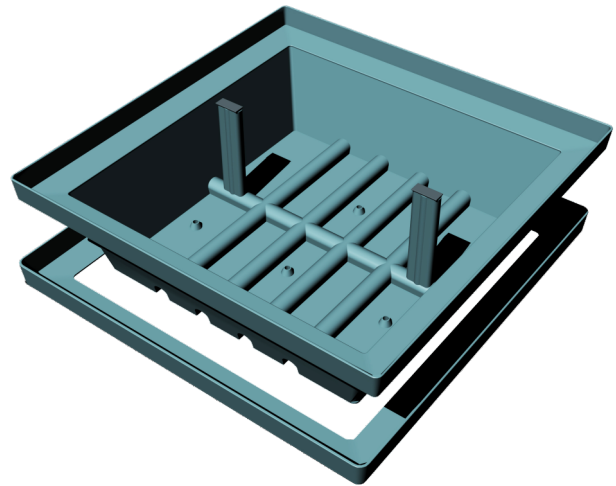

Tree Grating

Item	Loading Capacity	Clear Opening (O)	Inner Dia (ID)	Frame Size (F)	Frame Height (H)	Cover Thickness (h)	Net Weight (Kg.)
TGS-600	10/20 mt	600	200/400/600	765	65	40	40
TGS-750	10/20 mt	750	285/490/700	945	75	40	70
TGS-900	10/20 mt	900	355/560/770	1110	80	40	94

Lawn Cover

Item	Loading Capacity	Clear Opening (O)	Cover Size (D)	Frame Size (F)	Frame Height (H)	Cover Thickness (h)	Net Weight (Kg.)
LCS-450	700 kg	450	570	570	155	40	6
LCS-600	700 kg	600	715	715	160	40	10



Anti-Theft



Long Life



Aesthetics



Lightweight



Weather Proof

- Recessed manhole cover presented by **Dudhi FRP** in different sizes are to maintain continuity of floor-top finish, whether the floor covered with tile, stone or pave tile.
- The chamber as well as cover will not be visible except the thin line of frame of the recessed cover.

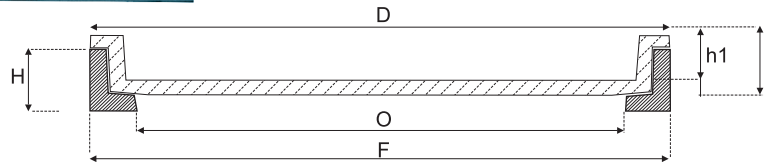
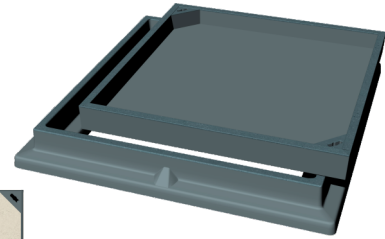
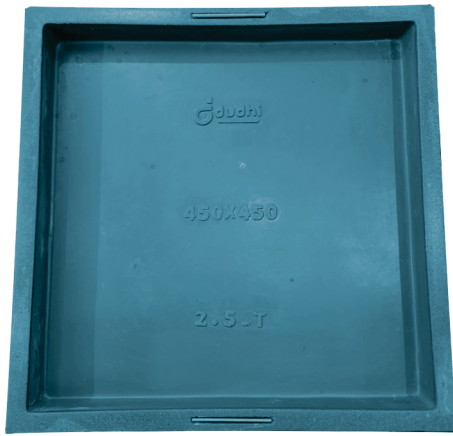

Item	Loading Capacity	Clear Opening (O)	Cover Size (D)	Frame Size (F)	Frame Height (H)	Cover Thickness (h)	Recessed Height (h1)	Net Weight (Kg.)
RCS-225	2.5/5 mt	225 x 225	300	325	55	55	40	10
RCS-225	10/20 mt	225 x 225	300	405	90	70	40	17
RCS-300	2.5/5 mt	300 x 300	400	400	55	55	40	11
RCS-300	10/20/40 mt	300 x 300	410	410	70	70	40	20
RCS-300	2.5/5 mt	300 x 300	385	410	95	95	80	15
RCS-300	10/20/40 mt	300 x 300	405	450	110	110	80	24
RCS-450	2.5/5 mt	450 x 450	535	560	60	60	40	17
RCS-450	10 mt	450 x 450	555	555	70	70	40	28
RCS-450	20/40 mt	450 x 450	530	630	90	65	40	32
RCS-450	2.5/5 mt	450 x 450	550	550	100	100	80	
RCS-450	10/20/40 mt	450 x 450					80	
RCS-600	2.5/5 mt	600 x 600	690	710	60	60	40	29
RCS-600	10 mt	600 x 600	700	700	70	70	40	40
RCS-600	20/40 mt	600 x 600	675	780	95	65	40	54
RCS-600	2.5/5 mt	600 x 600	678	710	100	100	80	36
RCS-600	10/20/40 mt	600 x 600	710	730	100	100	80	56
RCS-600	40 mt	600 x 600	700	830	190	150	100	124
RCS-750	10/20/40 mt	750 x 750	830	925	110	78	40	96
RCS-750	2.5/5 mt	750 X 750	850	900	110	110	80	74
RCS-750	10/20/40 mt	750 X 750					80	
RCS-900	10/20/40 mt	900 x 900	1025	1070	120	110	80	117



High load capacity & resilience

Hardness is more as cast iron, while FRP manhole covers have overwhelming advantages on resilience recovery. They are designed to exceed A2.5T, B5.0T, C12.5T, D25.0T, E40.0T, E60.0T load capacity, according to EN124: 1994.

Designed structure & pressure dispersion

Arc-shaped bottom structure allows the pressure they bear disperse averagely on the whole surface. Besides, the products are made not by SMC, it was put in several layers of fiber cloth to enhance the structures. So they are stronger than SMC composite manhole covers.

Consequences of temporarily overloading

Temporarily overloading may cause smash of concrete covers, seriously deformation, even slightly split. But this will not happen to FRP fiber cloth manhole cover.

Safety options

There is no metal contain, directly reducing potential accident or further maintenance costs caused by thieves. Anti-slip surface offer a safe road condition even in extreme weather.

Light weight

Compared with cast iron manhole cover, FRP manhole cover is 40% lighter. Light weight allows more loading per vehicle, more convenient transportation and economical savings. It allows a safer working condition, which a single worker is enough for installation without risk of injury.

Long Service life

Strong resistance of acid, alkali, weathering, anti corrosion of water, dust, manhole covers used for gas are well sealed which prevent poisonous gas leaking. Temperature tolerance is at the range of -40°C to 120°C.

Customer design

FRP manhole covers allow customers' innovative design, logo, or etc. we have our own design team who can also offer design work for customers.

No color fading

The cover is not sprayed in surface but painted in whole material so that the color can keep no fading.

No noise

The products are made anti-noises, which is popular to residential areas.



Lockable



Low - Noise



Customer
Design



Shock
Proof



Low
Maintenance

► Physical Charactorstics

Parameter	Dudhi FRP Products
Application	Green Belt, Sidewalk, Pedestrian, Driveway, Highway.
Surface Treatment	Anti-Slip, anti-UV
Technique	Mould pressing
Shape	Circle, Square, Rectangular or Customize
Color	Standard grey and as required on demand
Working Temperature	-40°C to 120°C
Service Life	More than 50 years
Working Condition	Anti Corrosion, anti uv, anti acid and alkali, anti-rusts etc.
Conduction	Non-electricity conduction and non-heat conduction
Noise	Less noise and lower vibration
Packing	Carton and as per customer's request

► Performance

Description	CI	RCC	Dudhi FRP
Life Span	Moderate	Low	High
Strength	Moderate	Very Low	Very High
Cost	Moderate	Low	Comparable to CI
Weight	Light	Heavy	Light
Manufacturing System	Manually Casted	Manually Compress	Molecular Binding Technique
Material	Cast Iron	Steel Fiber Reinforced Concrete	Glass Fiber Re-inforced Polymer
Water Absorptive/24hours	High Water Absorptive	High Water Absorptive	10-30 grm
Carbon Content	5-10 %	-	Carbon Free
Scrap Value	High	Low	Nil(Zero Value)
Anti Acid/Alkaline	Affected	Affected	Not Affected
Colour Range	Black	Concrete Grey	Range Available
Logo Embossing	Not Available	Not Available	Possible
Flexibility	Bend with load	Bend with load	Come back in bending
Custom Design/Size	Not Available	Not Available	Possible
Handling	Difficult	Very Difficult	Easy Compressive
Strength	Not mentioned	Not mentioned	300-600 Mpa
Thermal Expansion	High	Negligible	Nil
Noise(vehicle movement)	Noise Generate	Noise Generate	No Noise Generate
Break Elongation Ratio	More than 10%	More than 30%	1.3-10%
Corrosion Resistance	Affected with short span	Affected with short span	No Corrosion Affected
Abrasion Resistance	None	None	Yes



► SFRC/CI Manhole Cover condition after some time

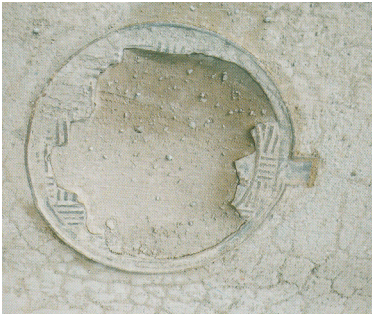

► Dudhi FRP products



Central Park 3, Gurugram



Tata Intellion Park, Gurugram



Ascendes IT Park, Gurugram



NDMC, Delhi



PWD, Aurbindo Marg, New Delhi



Beverly Golf Avenue, Mohali



NDMC, Delhi



Sun Twilight, Greater Noida



NDMC, Delhi



Anti-Theft



Long Life



Aesthetics



Lightweight



Weather Proof

► How to choose a suitable manhole cover load capacity?

The manhole covers load capacities can be divided into 5 categories:

	Category	Description
A	Load 2.5T (Point Load/Wheel load 0.8T)	Areas where can be used by footways, pedestrians areas, side walking ways, or pedal cyclists.
B	Load 5T (Point Load/Wheel load 2.5T)	Suitable for use in areas with Light Motor Vehicle traffic underground parking or parking decks in residential areas.
C	Load 10.0T (Point Load/Wheel load 3.0T)	Areas where can be used by footways, car parks, driveways, etc.
D	Load 20.0T (Point Load/Wheel load 5.0T)	Roads for relatively slow moving traffic, i.e. minor residential, cul-de-sacs and frequent traffic area.
E	Load 40.0T (Point Load/Wheel load 11.5T)	Areas such as power stations, carriageways, hard shoulders, parking areas for all vehicle types. For high density traffic conditions we recommend the use of a vibration resistant locking system.

► Technical Specification

Description	Dudhi Manhole Cover
Longitudinal strength	250-600 Mpa
Compressive strength	300-600 Mpa
Stretch modulus	25-35 Gpa
Break elongation ratio	1.3-10.0%
Bending strength	700-1400 Mpa
Poisson-ratio	0.35
Relative density	1.11-1.15
Water-absorption (24h)	10-30 mg
General Application (Working Temperature)	-40°C~120°C

► Testing Standards

FRP/GRP/COMPOSITE manhole covers are tested for load bearing and permanent set as per BS EN 124:1991 and IS 1726. BS EN 24 is testing code worldwide for Manhole covers in Cast iron, Ductile iron and other materials also. Permanent deformation in cover after multiple loading within a short time as specified in the code.



World Residency



International Trade Fair, New Delhi



Shock Proof



Zero Maintenance



High-Load Capacity



No-Colour Fading



Leak Proof

► Transport

During the transportation of manhole cover, it should avoid massive strike of uncertain part. Manhole cover should adjust correctly to the frame.

► How to choose the dimension of manhole cover?

The clear opening (co in short) of the frame should be equal to the manhole co, or larger than the manhole diameter, which can avoid the part of the frame hang in the air, the wrong transfer of loading pressure.

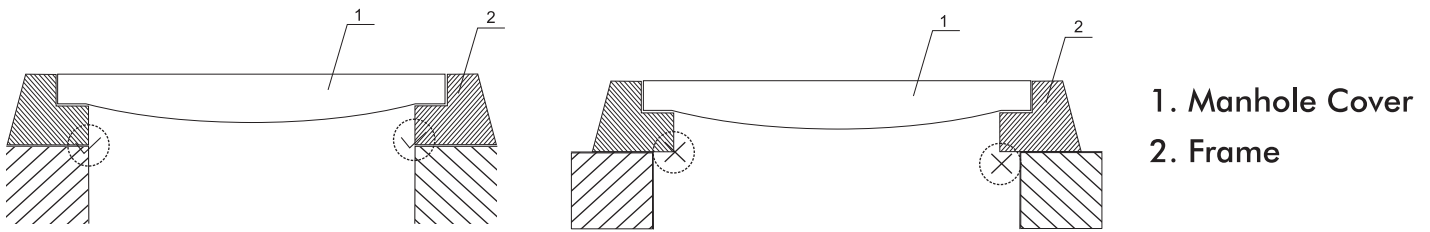

Measures of remediation:

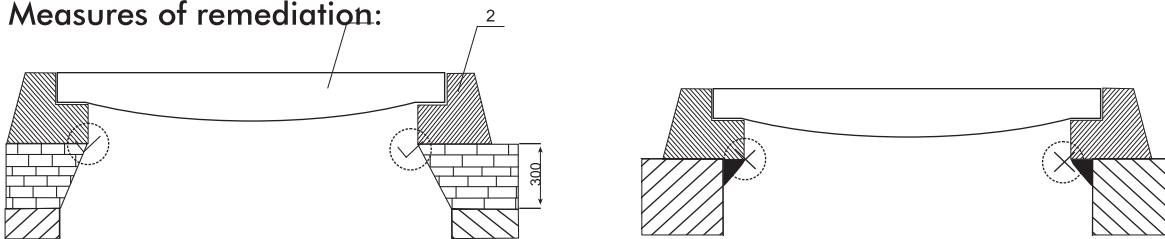

Notice : The basic level of the manhole should be compacted and level to avoid subsides of the manhole cover after massive pressure. The masonry wall should be integrity, the close up should be uniform

► The frame should be fastness well.

The frame bottom should be casting the concrete C25 or even better, the frame around concrete width (w) should be more than 300 mm. the bottom (D) concrete should be more than 200 mm.

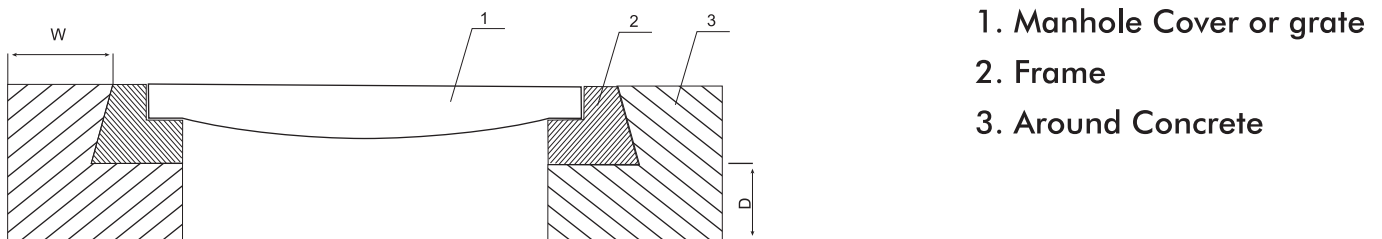

► **The manhole cover surface should be highly consistent with the ground.**

Estimation error range < + - 2mm

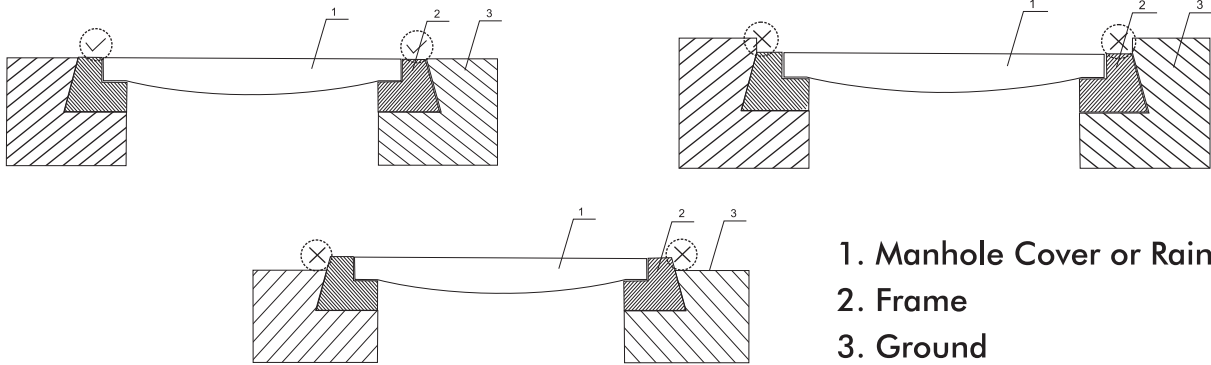

1. Manhole Cover or Rain Gate
2. Frame
3. Ground

► **Asphalt pavement construction program**

Fasten the frame by pre-cast concrete (c25, c30, c35), and maintain the pre-cast concrete more than 72 hours, then pave the asphalt. The cover frame should avoid the large-scale construction achinery rolling on.

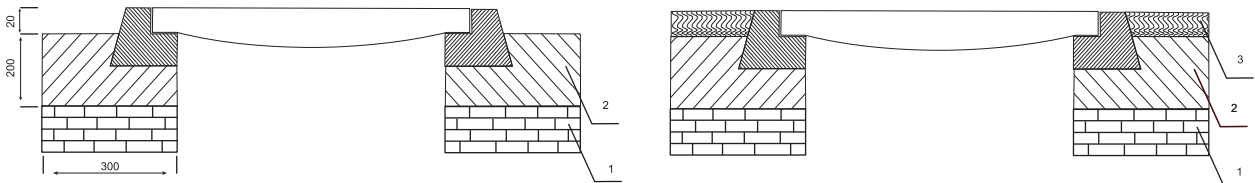

- A. To support and fasten, there must be 10-20mm cement paste under the frame.
- B. The frame should be surrounded by concrete with 300 mm width, and 200mm height.
- C. The frame can be 20mm above the ground for asphalt pavement.

1. Manhole co should be equal or less than the frame co.
2. Concrete base.
Asphalt material

► **Manhole cover right side up**

Reverse side up will easily broken and reduce the loading capacity.

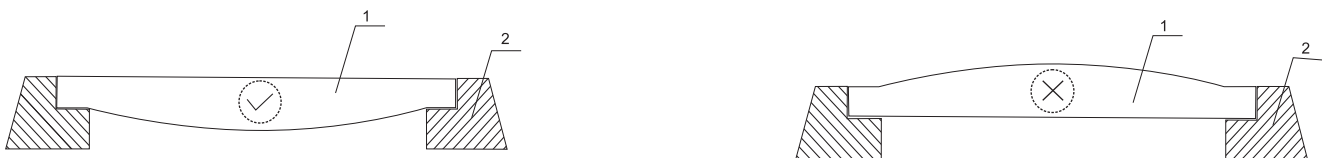

1. Manhole Cover or Rain Gate
2. Frame

► **Expansion backup gap.**

If the cover or grate have no frame, we should guarantee the expansion backup gap. (total gap width normally be 3-5 mm.)



Shock
Proof



Zero
Maintenance



High-Load
Capacity



No-Colour
Fading



Leak
Proof

Swachh Bharat Mission is a campaign in India that aims to clean up the streets, roads and infrastructure of cities, smaller towns, and rural areas.

Waste management is one of the primary problems that the world faces irrespective of the case of developed or developing country. The key issue in the waste management is that the waste were thrown in public places and It is not collected in garbage in proper manner. It in turn leads to various hazards such as bad odour & ugliness to that place which may be the root cause for spread of various diseases. To avoid all such hazardous scenario and maintain public cleanliness and health this work is mounted on a smart garbage system which is known as 'Waste management system'.

Dudhi Industries offering an unique product for the solution for an easy waste management dust bin which is a composite material made of a polymer matrix with reinforced by Glass Fiber (FRP). These items are made from high quality polymer materials and are designed to last for long period of time as compared to traditional plastic dustbin available in the market.

There are two different sizes are available as dual & Tri pattern for the use of Plastic, Paper and Food waste subsequently and having capacity of 60 ltr x 3 and 60 ltr x 2, a large variety of sizes, shapes and colours can be customized, depending on the user's preferences.

Features:

- Strong & Durable
- More Aesthetics
- Light weight so easy to Handel
- Easy to pouring and disperses
- UV, Acid, Alkali and weather resistance
- Customized offerings in sizes and patterns

Scope:

- Green belt, Swimming pools, Public Areas
- Residential Apartments
- Commercial – Malls, Theatres, Office Complex
- Hospitality: Hotel lobby, Restaurant, Marriage Halls
- Health care premises
- Public place like Airport, Rly station, Auditorium etc

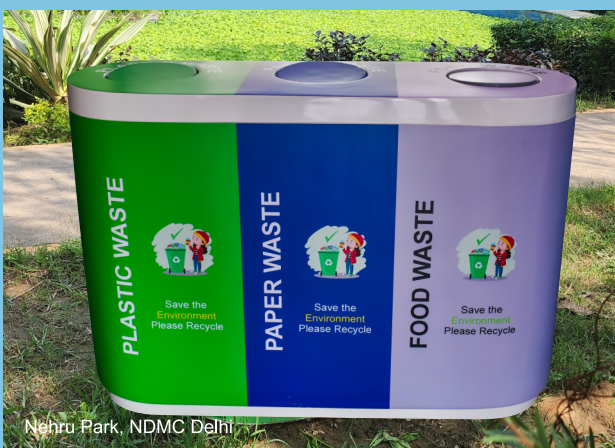

Model No.: DU/FRP/TRIO/60

WEIGHT : 28 KG APPROX.
CAPACITY : 60 LTR X 3
SIZE : L 47" X B 16" X H 32"

Model No.: DU/FRP/DUO/60

WEIGHT : 20 KG APPROX.
CAPACITY : 60 LTR X 2
SIZE : L 32" X B 16" X H 32"



Anti-Theft



Long Life



Aesthetics



Lightweight



Weather Proof

We take pleasure in introducing our innovative design solutions to make relationship between nature and human life which is precious and uncompromising.

Nowadays our high technology, gadget friendly cities may provide us with everything but we are totally missing out on opportunity of connecting to the elements of nature. Nature and its components when comes in sync with humans they restructure our brain patterns, and it's all for good. It causes rejuvenation and happiness.

We are a part of nature – let us reconnect with ourselves by making natural elements a bigger part of our daily lives.

Thoughtfully picked natural plants can offer meaningful interaction with nature with a psychologically restorative natural environment even in a dull and boring space.

Bringing garden indoors or having some greenery at work spaces & homes connects you directly with Mother Nature. Caring and growing plants around boosts moods, reduces stress, increases productivity and well-being and lets you breathe fresh with better air quality.

We believe that people with refined aesthetic sensibilities should have something palpably fashionable at their disposal.

How Self Watering Works

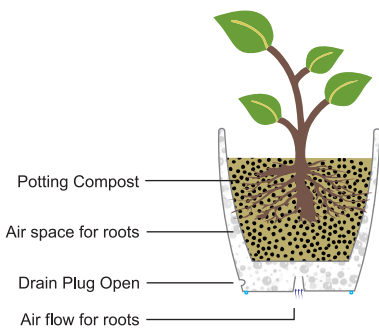

Dudhi Planter

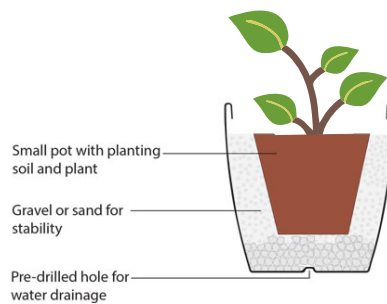

Other Planter

- Ventilation
- Excess Water Management
- Easy Portability

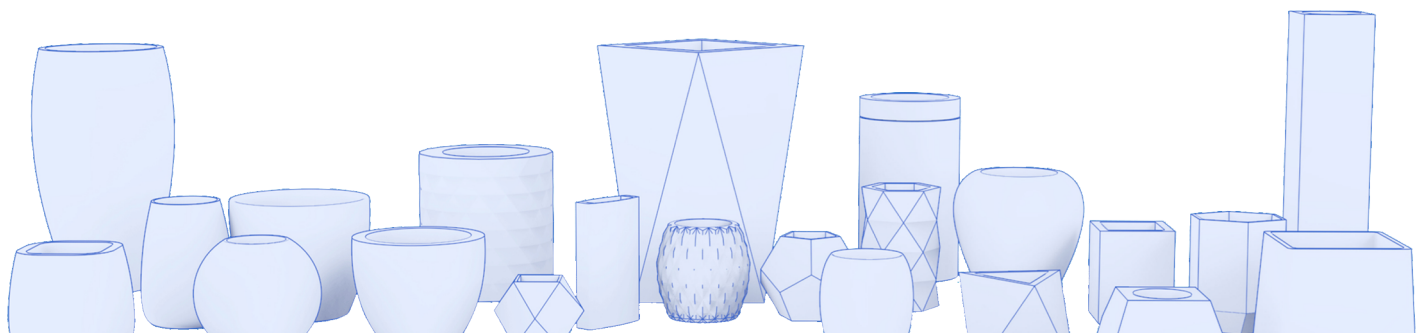
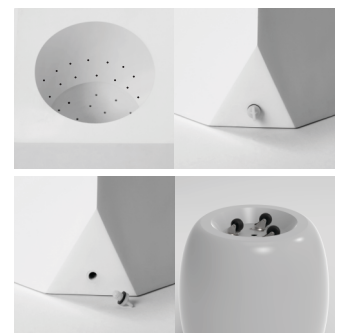

Non-fading Colours



Easy to Clean



UV Stable



Anti Frost



भारत सरकार
केन्द्रीय लोक निर्माण विभाग
कार्यालय: मुख्य अभियंता, नई दिल्ली अंचल-2
कमरा संख्या 252, विद्युत भवन, शंकर मार्केट,
नई दिल्ली - 110001
दूरभाष: 23412788, फैक्स: 23412787
ई-मेल: ce_ndz2@nic.in



पत्र सं023(3)/का.अभि.(सो)/न.दि.अं-2/न्यू प्रॉडक्ट प्रेजेंटेशन/2020/2023 दिनांक:- (8/11/2020)

OFFICE MEMORANDUM

विषय: Approval of M/s Dudhi Industries Pvt. Ltd. to incorporate in Tender documents for Civil works.

Consequent upon the request received from M/s Dudhi Industries Pvt. Ltd. vide their letter No. NIL dated 13/07/2020, Chief Engineer, NDZ-2, CPWD, New Delhi has approved following products manufactured by the said company for incorporating in approved brand list of materials in NITs for upcoming works under jurisdiction of NDZ-II.

Sl. No.	Description of item	Brand of Products	Remarks/Validity Period
1	FRP Manhole cover/gully & gratings	M/s Dudhi Industries Pvt. Ltd.	Validity upto 01 (One) year from issue of this letter.

- The above approval is for a period of one year from date of issue of this order. The approval will automatically lapse at the end of this period.
- EEs are required to incorporate the above brands along with already approved other brands in the List of Approved in the NITs/Des approved by them, in respect of works executed under the jurisdiction of NDZ-II.
- The approval does not absolve the Executive/Supervisory officers concerned of their responsibility of exercising necessary checks like quality, rates and performance of the products while processing/using the same. Short comings/deficiencies of serious nature, if observed while in use at site may be brought to the notice of this office.

P.T.O.



कार्यालय सहायक अभियंता
लोक निर्माण विभाग
सेन्ट्रल एवं नई दिल्ली उपमंडल-3233, लो.मि.वि
एम.एस.ओ. भवन, नई दिल्ली
e-mail :- aem3233mso@gmail.com

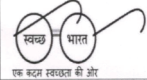

दिनांक: 28/01/2021

WHOM SO EVER IT MAY CONCERN

I am pleased to mention that the sewerage item of Dudhi FRP Manhole Cover provided by M/s Dudhi Industries Pvt Ltd, a particular size of 600 mm circular pattern having load bearing capacity of 10 M.Ton as required for the location of Trade and Tax Building premises which is under our maintenance Area.

The said Trial has been executed successfully on 28th July 2020 and the traffic movement of Light Motor vehicles are continually passing through the said Manhole cover.

So far the observation is taken during the course of period that the display/trial of the said product is most suitable for the purpose and the performance of the product is well appreciating with its aesthetic value.

In addition, I can say the company efforts to manufacturing the such product in India is showing the honest working and the well recommendation for planning of execution. The dedication and term spirit of company will help us to develop such product in the market which is most essential for the future prospects.

Our Heartiest Congratulations.

Best Wishes

Assistant Engineer
C&ND Bldg, M-3233
MSO Bldg, Delhi



NEW DELHI MUNICIPAL COUNCIL

MATERIAL TESTING LABORATORY
QUALITY CONTROL CELL
VIDYUT BHAWAN, NEW DELHI

Test report No : 322_14.02.2022
Date of receipt : 14.02.2022
Date of report : 15.02.2022

Test Results

- Name of work : 9-B Suspense Stock during 2021-22
- Sub Head : Supply and Stacking of fiber reinforced polymer (FRP) GT & Manhole cover with frame in NDMC store.
- Name of Division : Store
- Agency : M/s Shiv Traders
- Description of Sample: (A) GT Cover with frame for 450mmx500mm size of FRP material of Dudhi, NDMC, 2022 mark.
(B) GT Cover with frame for 560mm dia. of FRP material of Dudhi, NDMC, 2022 mark.
(C) Manhole Cover with frame for 500mm dia. of FRP material of Dudhi, NDMC, 2022 Mark.
(D) FRP Manhole cover with frame for 300x300mm, size of Dudhi, NDMC, 2022 mark.

Sr. No.	Test	Result	Required Limits
(A) GT Cover with frame for 450mmx500mm size of FRP material of Dudhi, NDMC, 2022 mark.			
1	Sample Marked A1 Load Test	5.50 MT (Passed Standard)	5.00 MT Min.
(B) GT Cover with frame for 560mm dia. of FRP material of Dudhi, NDMC, 2022 mark.			
1	Sample Marked A2 Load Test	6.00 MT (Passed Standard)	5.00 MT Min.
(C) Manhole Cover with frame for 500mm dia. of FRP material of Dudhi, NDMC, 2022 mark.			
1	Sample Marked A3 Load Test	12.50 MT (Passed Standard)	10.00 MT Min.
(D) FRP Manhole cover with frame for 300x300mm, size of Dudhi, NDMC, 2022 mark.			
1	Sample Marked A4 Load Test	5.75 MT (Passed Standard)	5.00 MT Min.

- NOTES:
- This report is being issued on the understanding that NDMC will not in any way be involved in any action following the interpretation of the above matter / results.
 - Sample not taken by Laboratory staff.

Assistant Engineer-II(QC&TA)-I

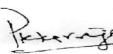
A.E/EE (QC&TA)-I



SHRIRAM INSTITUTE FOR INDUSTRIAL RESEARCH

(A unit of Shriram Scientific and Industrial Research Foundation)

19, University Road, Delhi - 110007 (India) Website: www.shriraminstitute.org
An ISO - 9001, 14001 & OHSAS 18001 Certified Institute E-mail id: customercare@shriraminstitute.org

TEST CERTIFICATE

NO : C/1/0000230591

Issued To:	Date:
Client Code : (NDLSOIC1092)	: 06-10-2020
CENTRAL PUBLIC WORKS DEPARTMENT	Job No : 2009-1-181-2974
OO THE CHIEF ENGINEER,	Booking No : RG2021/14873
NDZ-2, CPWD, VIDYUT BHAWAN, CONNAUGHT	Booking Date : 29-09-2020
PLACE,	Customer Ref No. : LETTER NO. 23(3)/KA. ABH[YO.]NDZ-
NEW DELHI	2/NEW PRODUCT PRESENTATION/2020/1708
DELHI-110001	Customer Ref Dt. : 28-09-2020

Sample Description :-
ONE TAPE SEALED AND SIGNED SAMPLE DESCRIBED AS FRP MANHOLE COVER 600 MM DIA, EHD-40 MT [DUDHI MAKE], WAS RECEIVED.

(The sampling was not carried out by Shriram Institute for Industrial Research. The sample particulars provided in certificate are based on declaration by the Customer).

Job NO.: 2009-1-181-2974

Results

S.No	Name of Parameter	Observed Value	Requirement	Conformity	Protocol
1	Load Test	Passes the Test	IS: 1726-1991, RA-2017	Yes	IS: 1726-1991, RA-2017
	(Load of 400 KN for 30 Seconds)		To Pass the Test		

	D.O.R.:- 29.09.2020				
	D.O.C.:- 06.10.2020				

ATTESTED TRUE COPY

Authorised Signatory

AUTHORISED SIGNATORY
EMPLOYEE CODE: (4167)



GOVERNMENT OF INDIA
MINISTRY OF CORPORATE AFFAIRS
Central Registration Centre

Certificate of Incorporation

[Pursuant to sub-section (2) of section 7 of the Companies Act, 2013 (18 of 2013) and rule 18 of the Companies (Incorporation) Rules, 2014]

I hereby certify that DUDHI INDUSTRIES PRIVATE LIMITED is incorporated on this First day of March Two thousand seventeen under the Companies Act, 2013 (18 of 2013) and that the company is limited by shares.

The Corporate Identity Number of the company is U26999HR2017PC06793.

The Permanent Account Number (PAN) of the company is AAGCD0484L *

Given under my hand at Manesar this First day of March Two thousand seventeen.



Digital Signature Certificate
Mr KAILASH CHAND MEENA
Deputy Registrar Of Companies
For and on behalf of the Jurisdictional Registrar of Companies
Registrar of Companies
Central Registration Centre

Disclaimer: This certificate only evidences incorporation of the company on the basis of documents and declarations of the applicant(s). This certificate is neither a license nor permission to conduct business or solicit deposits or funds from public. Permission of sector regulator is necessary wherever required. Registration status and other details of the company can be verified on www.mca.gov.in

Mailing Address as per record available in Registrar of Companies office:

DUDHI INDUSTRIES PRIVATE LIMITED
F 238-239, FIRST FLOOR, PALAM CORPORATE PLAZA, PALAM
VIHAR, GURGAON, Gurgaon, Haryana, India, 122017

* as issued by the Income Tax Department

3/2/2021

Print : Udyam Registration Certificate



Type of Enterprise	SMALL	Major Activity	Manufacturing
Type of Organisation	Private Limited Company	Name of Enterprise	M/S DUDHI INDUSTRIES PRIVATE LIMITED
Owner Name	M/S DUDHI INDUSTRIES PRIVATE LIMITED	PAN	AAGCD0484L
ITR for Previous Year	Yes	ITR Type	ITR - 3, 5, 6
Do you have GSTIN	Yes	Mobile No.	9311315461
Email Id	dudhiplaster@gmail.com	Social Category	General
Gender	Male	Specially Aabled(DIVYANG)	No
Date of Incorporation	01/03/2017	Date of Commencement of Production/Business	01/03/2017

Bank Details

Bank Name	ICICI BANK
IFS Code	ICIC0002452
Bank Account Number	245205000167

Employment Details

Male	25
Female	3
Other	0
Total	28

Investment in Plant and Machinery OR Equipment (in Rs.)

Written Down Value (WDV) as on 31st March of the Previous Year 2018-19 (A)	19752990
Exclusion of cost of Pollution Control, Research & Development and Industrial Safety Devices during 2018-19	0
Net Investment in Plant and Machinery OR Equipment[(A)-(B)]	19752990
Total Turnover (A) during 2018-19	15114869
Export Turnover (B) during 2018-19	0
Net Turnover [(A)-(B)]	15114869

Unit(s) Details

SN	Unit Name	Flat	Building	Village/Town	Block	Road	City	Pin	State	District
1	DUDHI INDUSTRIES PVT LTD	Factory Kharsa 70669	Naurangpur Road	Jhajjar		Silana	Jhajjar	124103	HARYANA	JHAJJAR
2	DUDHI INDUSTRIES PVT LTD	56/4	Chak 6 PRM	DANTOR	CHAK 6 PRM	PUGAL ROAD	BIKANER	334003	RAJASTHAN	BIKANER

Official address of Enterprise

Flat/Door/Block No.	F-238,239	Name of Premises/ Building	TOWER-B
Village/Town	PALAM VIHAR_BLOCK-C2	Block	ANSAL CORPORATE PLAZA
Road/Street/Lane	SECTOR-3	City	GURGAON
State	HARYANA	District	GURUGRAM_Pin : 122017
Mobile	9311315461	Email:	dudhiplaster@gmail.com

National Industry Classification Code(S)

<https://udyamregistration.gov.in/PrintApplication.aspx?Udmr=gp0tmzkeKl0vR6ApvyAroA==>

3/4

UQSR. Certificate

UQSR Global Private Limited has assessed the Quality Management System of:

Dudhi Industries Pvt. Ltd.

Manufacturing Plant I:- 56/4, Chak 6PRM, Pugal Road Dantor, Tehsil- Khajuwala, District- Bikaner, Rajasthan – 334004, India

Manufacturing Plant II:- Khasra No- 60, Naurangpur Road, Village Silana, Teh.-Jhajjar, District- Jhajjar, Haryana – 124103, India

And hereby declares that the management system of organization is in conformance with:

ISO 9001:2015

For the following scope of activities:

Manufacturing and Supply of Gypsum Plaster, Plaster of Paris, Block Mortar, Tile Adhesive, Wall Putty, FRP Planters, FRP Manhole Covers

Further clarification regarding the scope of this certificate and the applicability of Quality Management System standard requirements may be obtained by contacting the organization

Certificate No. UQSR-3029-DIPL

Original Issue Date: 10/11/2022

Expiry Date: 09/11/2023

Current Issue Date: 10/11/2022

Recertification Due Date: 09/11/2025

IAF Code. 12, 16

Issue No. 01

*Validity of certificate is subjected to the continued satisfactory performance during surveillance audit



Authorized By

Certification Manager

UQSR Global Private Limited
Formerly known as

Universal Quality Standards Registrar
www.uqsr.org

For information concerning validity of certificate, you can visit the site: www.uqsr.org

This document is property of UQSR and should be returned on request. Any unauthorised alteration, forgery or fabrication of the content or appearance of this document is unlawful and offenders may be prosecuted to the fullest extent of the law.

UQSR. Certificate

UQSR Global Private Limited has assessed the Environment Management System of:

Dudhi Industries Pvt. Ltd.

Manufacturing Plant I:- 56/4, Chak 6PRM, Pugal Road Dantor, Tehsil- Khajuwala, District- Bikaner, Rajasthan – 334004, India

Manufacturing Plant II:- Khasra No- 60, Naurangpur Road, Village Silana, Teh.-Jhajjar, District- Jhajjar, Haryana – 124103, India

And hereby declares that the management system of organization is in conformance with:

ISO 14001:2015

For the following scope of activities:

Manufacturing and Supply of Gypsum Plaster, Plaster of Paris, Block Mortar, Tile Adhesive, Wall Putty, FRP Planters, FRP Manhole Covers

Further clarification regarding the scope of this certificate and the applicability of Environment Management System standard requirements may be obtained by contacting the organization

Certificate No. UQSR-3030-DIPL

Original Issue Date: 10/11/2022

Expiry Date: 09/11/2023

Current Issue Date: 10/11/2022

Recertification Due Date: 09/11/2025

IAF Code: 12, 16

Issue No. 01

*Validity of certificate is subjected to the continued satisfactory performance during surveillance audit



Authorized By

Certification Manager

UQSR Global Private Limited
Formerly known as

Universal Quality Standards Registrar
www.uqsr.org

For information concerning validity of certificate, you can visit the site: www.uqsr.org

This document is property of UQSR and should be returned on request. Any unauthorised alteration, forgery or fabrication of the content or appearance of this document is unlawful and offenders may be prosecuted to the fullest extent of the law.

 Solan (Himachal) & Delhi NCR Various Projects	 PWD Delhi	 NSEZ, Phase-2, Noida
 Delhi NCR Various Projects	 Central Vista Parliamentary division Mussoorie polo ground	 I-130, AIGIN Park Avenue, Gaur City, Sec-4, Greater Noida West
 Sec-62, Gurugram	 NTPC, Telangana	 Gaur City-2, Gr. Noida-201009 Sector-8, Faridabad-121006
 Sector 82, 83, 88, 89 Gurugram	 AIIMS Jhajjar, Delhi	 Sector-71, Noida 201307
 Sec - 62, Gurugram	 Steel City Bokaro, Jharkhand	 AVENUE 37, HL CITY, Sector 37, Bahadurgarh, Haryana 124507
 Delhi NCR (Various Projects)	 FRP Manhole -Petrol pumps	 Sector-95, Gurugram 122009
 Delhi NCR (Various Projects)	 Pragati Maidan, New Delhi - 110001	 Sector-75, Noida 201301
 Noida & Lucknow	 NDMC Store, New Delhi	 Sector-26, Noida
 Sohna Road, Gurugram	 Charleville, Mussoorie, Uttarakhand 248179	 Sector-68, Gurugram 122103
 Sector 37D, Gurugram	 12 Noida Special Economic Zone, Plot 142 A/11, Cappemini Rd, Phase-2, Noida, U. P. - 201305	 Chattarpur, New Delhi 110074
 Gurugram - Sec - 84	 Gr. Noida, Uttar Pradesh	 Sector-4, Gr. Noida 201309
 Indirapuram Ghaziabad	 Sector C, Poket -7, Golf City, Bagiamau, Lucknow, Uttar Pradesh 226002	 Sector-86, Faridabad 121002
 Sec-88, Faridabad, Gurgaon	 Plot No.-SC 01/B8, Sector 150, Noida, U.P.	 Sector-92, Gurugram
 Delhi	 SC-02/A9, Sector 150, Noida, Uttar Pradesh 201310	 Chandni Chowk, New Delhi 110006
 Sector -18, Noida	 Sector 102, Gurugram	 Raj Nagar Extension, Ghaziabad
 Delhi NCR (Various Projects)	 B4-704, Panchsheel Green 2, Noida Extantion, Ek Murti, Noida, U.P.	 Raj Nagar Extension, Ghaziabad
 Delhi NCR (Various Projects)	 Almoda, UK	 Reliance METL, Jhajjar 124103
 KW Mall Delhi	 Greater Noida West Link Rd, Tusiana Village, Knowledge Park V, Greater Noida, U.P. - 201306	 Sector-67, Mohali

कीमत नहीं, गुणवत्ता देखें।



Dudhi Industries Pvt. Ltd.

Corporate Office: F-238,239, Tower-B, Palam Corporate Plaza, Palam Vihar, Gurugram-122 017 (HR.)

Regd. Office: B-1/2, Ashok Vihar Phase - III, Gurugram-122001(HR.)

Manufacturing Plants:

- M.No.- 56/4, Chak 6PRM, Pugal Road, Dantor, Tehsil - Khajuwala, Dist.-Bikaner, (Raj.)
- Khasra No.-60, Naurangpur Road, Village- Silana, Tesil-Jhajjar, District-Jhajjar-124103 (HR.)

T : +91 9560393000, +91 9560393006

E : info@dudhi.in | **W :** www.dudhi.in